



D4272  
RESIDENTIAL

# Digital Thermostat

Optional accessories  
available, including Wi-Fi



Owner's  
Manual  
and  
Installation  
Instructions



## CAUTION

Follow the Installation Instructions before proceeding. Set the thermostat mode to “OFF” prior to changing settings in setup or restoring Factory Defaults.

---

### FCC Compliance Statement

This equipment has been tested and found to comply with the limits for an intentional radiator, pursuant to Part 15, subpart C of the FCC rules. These limits are designed to provide reasonable protection against harmful interference in a residential installation. This equipment generates, uses and can radiate radio frequency energy and, if not installed and used in accordance with the instructions, may cause harmful interference in radio communications. However, there is no guarantee that the interference will not occur in a particular installation. If this equipment does cause harmful interference to radio or television reception, which can be determined by turning the equipment off and on, the user is encouraged to try to correct the interference by one or more of the following measures:

- Reorient or relocate the receiving antenna.
- Increase the separation between the equipment and receiver.
- Connect the equipment into an outlet on a circuit different from that of the receiver.
- Consult the dealer or an experienced radio or TV technician for help.

Notice: Only peripherals complying with FCC limits may be attached to this equipment. Operation with noncompliant peripherals or peripherals not recommended by Venstar, is likely to result in interference to radio and TV reception. Changes or modifications to the product, not expressly approved by Venstar could void the user's authority to operate the equipment.

### FCC - INDOOR Mobile Radio Information:

To comply with FCC/IC RF exposure limits for general population / uncontrolled exposure, the antenna(s) used for this transmitter must be installed to provide a separation distance of at least 20 cm from all persons and must not be co-located or operating in conjunction with any other antenna or transmitter.

This Device complies with Industry Canada License-exempt RSS standard(s). Operation is subject to the following two conditions: 1) this device may not cause interference, and 2) this device must accept any interference, including interference that may cause undesired operation of the device.

Under Industry Canada regulations, this radio transmitter may only operate using an antenna of a type and maximum (or lesser) gain approved for the transmitter by Industry Canada. To reduce potential radio interference to other users, the antenna type and its gain should be so chosen that the equivalent isotropically radiated power (e.i.r.p.) is not more than that necessary for successful communication.

*Cet appareil est conforme avec Industrie Canada, exempts de licence standard RSS(s). Son fonctionnement est soumis aux deux conditions suivantes: 1) ce dispositif ne doit pas causer d'interférences, et 2) ce dispositif doit accepter toute interférence, y compris les interférences qui peuvent causer un mauvais fonctionnement de l'appareil.*

*En vertu des règlements d'Industrie Canada, cet émetteur de radio ne peut fonctionner en utilisant une antenne d'un type et maximale (ou moins) Gain approuvé pour l'émetteur par Industrie Canada. Pour réduire les interférences radio potentielles aux autres utilisateurs, le type d'antenne et son gain doivent être choisis afin que la puissance isotrope rayonnée équivalente (PIRE) ne est pas plus de ce qui est nécessaire pour une communication réussie.*

We, Daikin, declare under our sole responsibility that the device to which this declaration relates: Complies with Part 15 of the FCC Rules. Operation is subject to the following two conditions: (1) this device may not cause harmful interference, and (2) this device must accept any interference received, including interference that may cause undesired operation.

FCC ID: MUH-SKYPORT4

IC: 12547A-SKYPORT4

---

This thermostat has the ability to receive updates to its firmware. Periodically firmware updates are released by the manufacturer to add features and/or performance enhancements. This manual was produced reflecting the most current firmware/feature set at the time of publication, firmware rev. 1.0. Firmware releases after rev. 1.0 may not be adequately depicted in this manual. Please refer to the appropriate website or contact your place of purchase to learn about changes to the thermostat after firmware release 1.0.



Industry  
Canada

Industrie  
Canada

# Glossary of Terms

**Auto-Changeover:** A mode in which the thermostat will turn on the heating or cooling based on room temperature demand.

**Cool Setpoint:** The warmest temperature that the space should rise to before cooling is turned on (without regard to deadband).

**Deadband:** The number of degrees the thermostat will wait, once a setpoint has been reached, before energizing heating or cooling.

**Differential:** The forced temperature difference between the heat setpoint and the cool setpoint.

**Heat Setpoint:** The coolest temperature that the space should drop to before heating is turned on (without regard to deadband).

**Icon:** The word or symbol that appears on the thermostat display.

**Mode:** The current operating condition of the thermostat (i.e. Off, Heat, Cool, Auto, Program On).

**Non-Programmable Thermostat:** A thermostat that does not have the capability of running Time Period Programming.

**Programmable Thermostat:** A thermostat that has the capability of running Time Period Programming.

**Temperature Swing:** Same as Deadband.

**Time Period Programming:** A program that allows the thermostat to automatically adjust the *heat setpoint* and/or the *cool setpoint* based on the time of the day.

# Table of Contents

<b>GET TO KNOW YOUR THERMOSTAT</b>	
Get to Know Your Thermostat.....	1
Quick Start .....	6
<b>INSTALLATION INSTRUCTIONS</b>	
Installation Instructions .....	8
Sample Wiring Diagrams.....	12
Test Operation.....	15
<b>USER SETUP</b>	
Backlight Operation.....	16
Scrolling Display Options .....	17
Programming Vacation/Away.....	18
Emergency Heat .....	18
Wireless Module .....	19
Service Filter .....	21
Runtimes .....	21
Time Period Programming .....	23
<b>INSTALLER SETUP</b>	
Program Mode Operation.....	25
Setpoint Limits.....	26
Timers and Deadbands .....	27
Programming Fan Operation.....	28
Comfort Recovery Operation .....	28
Dry Contact Operation .....	30
Skyport.....	30
Local API.....	30
Factory Defaults.....	31
ADR .....	32
<b>TECHNICIAN SETUP</b>	
Equipment Testing .....	39
Advanced Setup Table .....	40
Troubleshooting .....	42
<b>INDEX</b> .....	43
<b>WARRANTY</b> .....	47

# Get To Know Your Thermostat

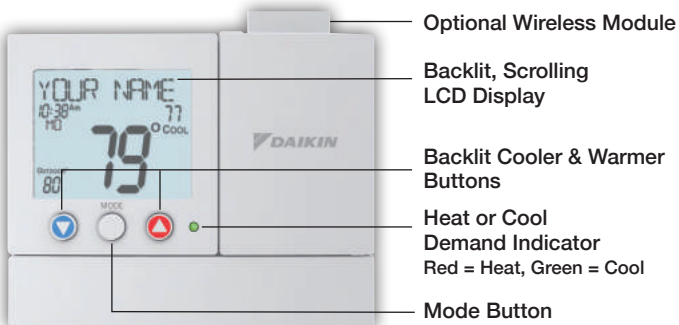

# Get To Know Your Thermostat



Setup Buttons

# Get To Know Your Thermostat

## Display Features

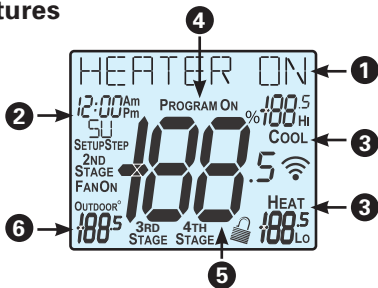



- 1** The scrolling display will be used to help you easily navigate the setup screens in the thermostat.
- 2** **Clock with Day of the Week**  
Indicates the current time and day. This clock is also used to program the time period schedules.
- 3** **Mode Indicators**  
Selects the operational mode of the equipment.  
**HEAT** - Indicates the heating mode.  
**COOL** - Indicates the air conditioning mode.  
**HEAT & COOL** - Indicates the system will automatically change-over between heat and cool modes as the temperature varies.  
**OFF** - Indicates heating and cooling is turned off.
- 4** **Program icon**  
Indicates that Time Period Programming is running or is enabled to be set.
- 5** **Room Temperature Display**  
Indicates the current room temperature and displays the outdoor temperature when selected.
- 6** **Outdoor icon**  
Indicates the temperature displayed is from the optional outdoor sensor.

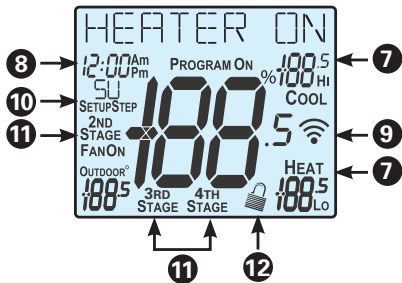

# Get to know your thermostat

## Display Features



- 7** **Desired Set Temperature**  
Indicates desired room temperature(s). Also displays the highest and lowest temperatures for the day.
- 8** **Morning, Day, Evening & Night icons**  
Indicates the day part of the time period program.
- 9** **Wi-Fi icons**  
Indicates the thermostat is currently connected to the Local Area Network, via the optional Wi-Fi module.
- 10** **Setup Step icon**  
Indicates the step number when the thermostat is in the setup mode.
- 11** **2nd, 3rd and 4th Stage icons**  
Indicates what stage of cooling or heating is currently energized.
- 12**  **icon**  
Indicates the keypad has been locked.

# Get to know your thermostat

## Display Features

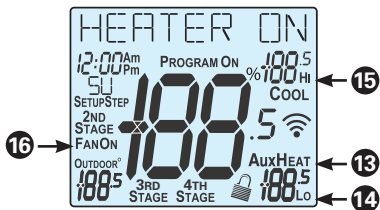

### 13 AuxHeat icon

Indicates 2nd stage electric strip heat is being used when the thermostat is programmed for Heat Pump operation. Only the Aux icon will appear during Cool to Dehumidify to indicate Reheat operation.

### 14 Lo icon

Indicates the lowest recorded outdoor temperature for the day.\*

### 15 Hi icon

Indicates the highest recorded outdoor temperature for the day.\*

### 16 Fan On icon

Indicates constant, continuous fan operation. When **Fan On** is not lit - indicates the fan will only operate when necessary to heat or to cool.

\* *Hi and Lo Temperatures for the day, reset at midnight.*

# Quick Start

## During Setup and Programming

Press the **WARMER** or **COOLER** buttons to modify the selection.

Press the **MODE** button to advance and confirm through the setup steps.

## Setting the Clock and Day\*

*\*Not available when wi-fi module is present*

Press the SET CLOCK button. Adjust the clock using the WARMER or COOLER buttons. Press MODE to advance to the day setting. Adjust the day using the WARMER or COOLER buttons. Press the SET CLOCK button to confirm settings.

**TIP:** To adjust the time by hours press and hold the FAN button while pressing the WARMER or COOLER buttons.



## Selecting the Heat or Cool Mode

Select mode by pressing the **MODE** button.

**Heating Only** - Only the heating operation will be controlled by the thermostat in this mode.

**Cooling Only** - Only the cooling operation will be controlled by the thermostat in this mode.

**Heating or Cooling (Auto-Changeover)** - AUTO will automatically select heat or cool based on room temperature demand.

**OFF** - OFF indicates both heating and air conditioning systems are turned off.



# Quick Start

## Selecting your desired temperature

**AUTO-CHANGEVER MODE** - Pressing the WARMER or COOLER buttons in Auto mode will adjust both the heat and cool setpoints simultaneously. To adjust heat and cool setpoints individually, choose HEAT mode to adjust the heat setpoint and COOL mode to adjust the cool setpoint, then return to AUTO mode.

**HEAT OR COOL MODE** - Pressing the WARMER or COOLER buttons in Heat or Cool mode will adjust only the heat or cool setpoints individually displayed.

## Using the Fan Button

**Fan On** indicates constant fan operation. You may turn the fan on even if the thermostat is in the OFF mode. Pressing the FAN button toggles this feature on or off. If you don't see "Fan On", the fan is in auto mode and will only turn on during a heat or cool demand.



## Viewing the Temperature Sensors

**OUTDOOR TEMP** - Press the OUTDOOR button to view the current outdoor temperature. The high and low temperatures for the day will also be displayed. The high and low temperatures reset at 12:00 am. Press the OUTDOOR button again to return to normal operation.



If the thermostat is connected to Skyport; upon pressing the OUTDOOR button the scrolling display will read "Forecast".

The forecasted high and low temperatures for the day will be displayed.

Press the OUTDOOR button again to view any connected wired sensor (remote or SUPPLY).

**Note: If no outdoor sensor is connected, and there isn't outdoor temperature via Wi-Fi, then 2 dashes [- -] will appear with the first button press.**

**REMOTE/SUPPLY TEMP** - Press the **Accessory Status** button to view linked wireless wired sensors and other accessories. Press the **Accessory Status** button to return to the main screen. Setup step #42 selects the use of the wired temperature sensor.



# Installation Instructions

## Remove and Replace the old thermostat

To install the thermostat properly, please follow these step by step instructions. If you are unsure about any of these steps, call a qualified technician for assistance.

- Assemble tools: Flat blade screwdriver, wire cutters and wire strippers.

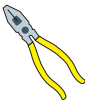

- Make sure your Heater/Air Conditioner is working properly before beginning installation of the thermostat.
- Carefully unpack the thermostat. Save the screws, any brackets, and instructions.
- Turn off the power to the Heating/Air Conditioning system at the main fuse panel. Most residential systems have a separate breaker for disconnecting power to the furnace.
- Remove the cover of the old thermostat. If it does not come off easily, check for screws.
- Loosen the screws holding the thermostat base or subbase to the wall and lift away.
- If you have a smart phone handy, take a photo of the wiring for future reference.
- Disconnect the wires from the old thermostat. Tape the ends of the wires as you disconnect them, and mark them with the letter of the terminal for easy reconnection to the new thermostat.
- Keep the old thermostat for reference purposes, until your new thermostat is functioning properly.

# Installation Instructions

## Wire Connections

If the terminal designations on your old thermostat do not match those on the new thermostat, **refer to the chart below or the wiring diagrams that follow.**

Wire from the old thermostat terminal marked	Function	Install on the new thermostat connector marked
G or F	Fan	G
Y1, Y	Cooling	Y1
W1, W	Heating	W1/O/B
Rh, R, M, Vr, A	Power	R
C	Common	C
O/B	Rev. Valve	W1/O/B*
W2	2nd Stage Heat	W2
Y2	2nd Stage Cooling	Y2
W3	3rd Stage Heat	W3
Ck1	Dry Contact Switch	DRY CONTACT
CKGND	Dry Contact Switch	DRY CONTACT

\* O/B is used if your system is a Heat Pump.

# Installation Instructions

## The Thermostat Backplate

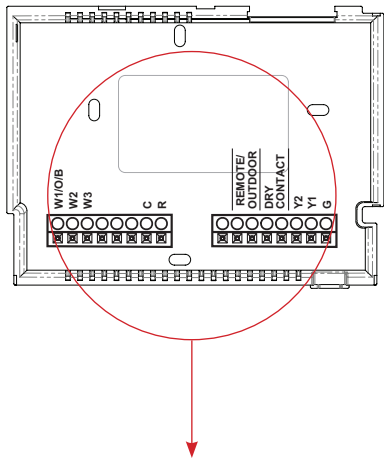

**To remove the thermostat backplate:** Gently separate the display from the base by pulling first from one side, then the other until the two pieces unsnap. A small screwdriver may be used, very carefully, to start separating the two pieces.

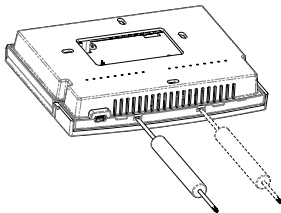

<b>R</b>	24 VAC return	<b>C</b>	24 VAC common
<b>G</b>	Fan relay	<b>REMOTE / OUTDOOR</b>	Wired sensor connections
<b>W1/O/B</b>	1st stage heat circuit	<b>DRY CONTACT</b>	Dry Contact connections
<b>W2</b>	2nd stage heat circuit		
<b>Y1</b>	1st stage compressor relay		
<b>Y2</b>	2nd stage compressor relay		
<b>W3</b>	3rd stage heat circuit		

**IMPORTANT:** This thermostat requires both **R (24 VAC Return)** and **C (24 VAC Common)** be connected to the backplate terminals.

# Installation Instructions

## Check Dip Switch

Ensure which switch is correct for your system. Dip switches are located on the back of the thermostat.

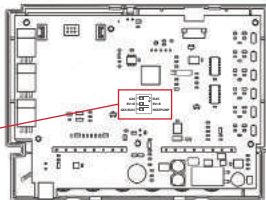
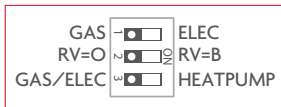

OR



1. When GAS/EL or HP is set for GAS/EL: This switch (GAS or ELEC) controls how the thermostat will control the Fan (G) terminal in heating mode. When GAS is chosen, the thermostat will not energize the Fan (G) terminal in heating. When ELEC is chosen the thermostat will energize the fan in heating.

2. When GAS/EL or HP is set for HP: This switch (GAS or ELEC) defines the Aux Heat type. When GAS is chosen, the auxiliary heat will not be allowed to run during heat pump operation. When ELEC is chosen, up to two stages of auxiliary strip heat will be allowed to run.



OR



For Heat Pump Only  
When the GAS/EL or HP dip switch is configured for HP, this dip switch (O or B) must be set to control the appropriate reversing valve. If O is chosen, the W1/O/B terminal will energize in cooling. If B is chosen, the W1/O/B terminal will energize in heating.



OR



This dip switch configures the thermostat to control a conventional gas/electric system or a heat pump. If your system is anything other than a heat pump, leave this switch set for GAS/EL.



# Installation Instructions

## Sample Wiring Diagrams

### Conventional Heating and Cooling Systems

#### 3 Wire, Heat Only

Residential & Commercial 1 Stage Heating with no Fan.

R      24VAC Power  
C      24VAC Common  
W1/O/B   1st Stage Heat

J1 = Gas/Elec  
J2 = O (not used)  
J3 = Gas

#### 4 Wire, Cool Only

Residential & Commercial 1 Stage Cooling.

R      24VAC Power  
C      24VAC Common  
Y1     1st Stage Cool  
G      Fan

J1 = Gas/Elec  
J2 = O (not used)  
J3 = Gas

#### 5 Wire, 1 Stage Cooling, 1 Stage Heat

Residential & Commercial 1 Stage Cooling, with 1 stage Gas Heat.

R      24VAC Power  
C      24VAC Common  
W1/O/B   1st Stage Heat  
Y1     1st Stage Cool  
G      Fan

J1 = Gas/Elec  
J2 = O (not used)  
J3 = Gas

#### 5 Wire, 1 Stage Cooling, 1 Stage Heat

Residential & Commercial 1 Stage Cooling, with 1 stage Electric Heat.

R      24VAC Power  
C      24VAC Common  
W1/O/B   1st Stage Heat  
Y1     1st Stage Cool  
G      Fan

J1 = Gas/Elec  
J2 = O (not used)  
J3 = Electric

#### 8 Wire, 2 Stage Cooling, 3 Stage Heat

Residential & Commercial 2 Stage Cooling, with 3 stage Gas Heat.

R      24VAC Power  
C      24VAC Common  
W1/O/B   1st Stage Heat  
W2     2nd Stage Heat  
W3     3rd Stage Heat  
Y1     1st Stage Cool  
Y2     2nd Stage Cool  
G      Fan

J1 = Gas/Elec  
J2 = O (not used)  
J3 = Gas

# Installation Instructions

## Sample Wiring Diagrams

### Heat Pump Systems

#### 5 Wire, 1 Stage Cooling, 1 Stage Heat

Residential & Commercial Heat Pump with  
'O' Reversing Valve

R	24VAC Power
C	24VAC Common
W1/O/B	Reversing Valve
Y1	1st Stage Compressor (Cool or Heat)
G	Fan
J1	= Heat Pump
J2	= O
J3	= Gas

#### 6 Wire, 1 Stage Cooling, 2 Stage Heat

Residential & Commercial Heat Pump with  
'O' Reversing Valve

R	24VAC Power
C	24VAC Common
W1/O/B	Reversing Valve
Y1	1st Stage Compressor (Cool or Heat)
W2	Aux Heat
G	Fan
J1	= Heat Pump
J2	= O
J3	= Electric

#### 7 Wire, 2 Stage Cooling, 3 Stage Heat

Residential & Commercial Heat Pump with  
'O' Reversing Valve.

R	24VAC Power
C	24VAC Common
W1/O/B	Reversing Valve
W2	3rd Stage Heat
Y1	1st Stage Compressor (Cool or Heat)
Y2	2nd Stage Compressor (Cool or Heat)
G	Fan
J1	= Heat Pump
J2	= O
J3	= Electric

Setup Step 24 is set to 2  
(Number of Compressor Stages)

#### 8 Wire, 2 Stage Cooling, 4 Stage Heat

Residential & Commercial Heat Pump with  
'O' Reversing Valve.

R	24VAC Power
C	24VAC Common
W1/O/B	Reversing Valve
W2	3rd Stage Heat
W3	4th Stage Heat
Y1	1st Stage Compressor (Cool or Heat)
Y2	2nd Stage Compressor (Cool or Heat)
G	Fan
J1	= Heat Pump
J2	= O
J3	= Electric

Setup Step 24 is set to 2  
(Number of Compressor Stages)

# Installation Instructions

## Sample Wiring Diagrams

### Dry Contact

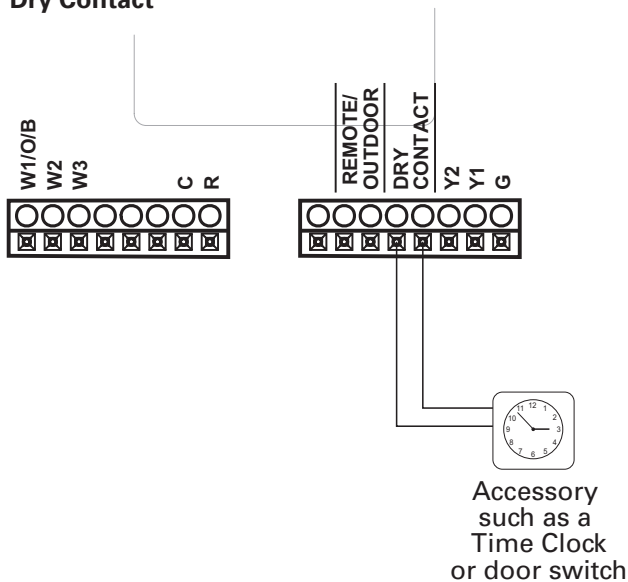

# Installation Instructions Test Operation

The thermostat has a diagnostic feature that enables testing of all outputs. This feature is contained in **Technician Setup**.

---

*To enter Technician Setup, press and hold the SETUP button for 5 seconds until all the icons appear. Follow the next steps to view settings and test equipment.*

---

1. Press MODE to view the version numbers of the thermostat.
2. Press MODE again to view the jumper settings and current state of the Dry Contact terminals.
3. Press MODE again and the scrolling display will read "TURN ON EQUIPMENT?" Press WARMER for Yes or COOLER for No.  
  
If Yes is chosen, press WARMER to turn on heat or COOLER to turn on Cooling. The scrolling display will read "NOTHING ON." Next:  
  
Press WARMER to turn on and cycle up through the heating stages. Press COOLER to turn the heating stages off. Press MODE to exit.  
  
Press COOLER to turn on and cycle down through the cooling stages. Press WARMER to turn the cooling stages off. Press MODE to exit.
4. Press MODE until "CALIBRATE SENSORS?" appears on the scrolling display. Press WARMER for Yes or COOLER for No. Press MODE to select which sensor to calibrate. Use WARMER or COOLER to modify your selection.

***To exit Technician Setup at any time, press the SETUP button. Technician Setup will automatically exit after 10 minutes if no buttons are pressed.***

# User Setup: Backlight Operation

## How to Change Settings in the Setup Screens

To enter Advanced Setup, press the **SETUP** button, then press **MODE**. Use the **WARMER** or **COOLER** buttons to adjust the value of your selection. Press **MODE** to advance to the next setup step. Press **SETUP** again to leave the setup screens.

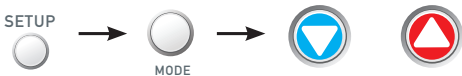

---

## Backlight (setup step 3-8)

### Backlight (setup step 3)

**Off** - Backlight turns on with any button press and turns off after 8 seconds.

**On** - Backlight is on continuously.

### Backlight Intensity Level (setup step 4)

The backlight can be adjusted between Off and seven levels of brightness.

**Night Dimmer (setup step 5)** - Selecting **On** allows for automatic dimming of the display at night.

### Night Dimmer Brightness (setup step 6)

Off through seven levels of brightness

**Night Dimmer Start Time (setup step 7)** - 12:00 am to 12:00 am

**Night Dimmer Stop Time (setup step 8)** - 12:00 am to 12:00 am

## Language (Setup Step 15)

Setup step instructions on the scrolling display can be set for English, Spanish, or French.

**Press the SETUP button, then press MODE repeatedly until the Language setup step appears. Use the WARMER or COOLER buttons to make selection. Press MODE to advance to the next step. Press SETUP to leave the setup screens.**

# User Setup: Scrolling Screen and Display Options

## Scrolling Display Method (Setup Step 16)

This option allows the user to choose how the scrolling text is displayed. Options are:

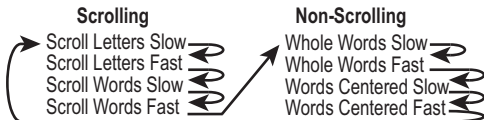

Press the SETUP button, then press MODE repeatedly until the Scrolling Method setup step appears. Use the WARMER or COOLER buttons to make selection. Press MODE to advance to the next step. Press SETUP to leave the setup screens.



### Example of "Whole Words Centered":

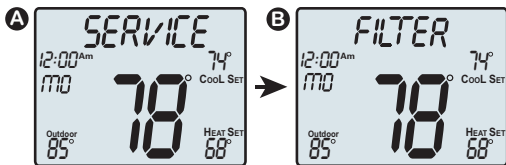

# User Setup

## Vacation & Away Settings

The Vacation feature allows the thermostat to use temporary, energy saving setpoints without having to change regular programming.



The HOME/AWAY feature allows for a one button press to bring in your stored unoccupied vacation settings. A subsequent press of the HOME/AWAY button restores the last used comfort settings.



Press the VACATION button to enter Vacation/Away programming. Use the WARMER and COOLER buttons to choose the number of days desired to run the in Vacation/Away settings.

To confirm your settings and advance to the next step, press the MODE button again. Choose the desired Vacation/Away Mode. Press the MODE again to adjust the 'unoccupied' setpoint. If you selected auto changeover mode for unoccupied/vacation settings, then pressing MODE again will allow the adjusting of the 2nd setpoint. Otherwise press MODE to confirm and return to normal operation.

Press the VACATION button again to return to the main screen. Both VACATION and AWAY use these same settings. VACATION button use specifies a duration of days for these settings, whereas Away maintains these settings until the HOME/AWAY button is pressed again.

When the VACATION button is pressed and the thermostat detects that a Wi-Fi module is installed:

During Non-Vacation Periods: the scrolling display will read:  
"Use Skyport to View/Edit Settings"

During Vacation Period: the scrolling display will read:  
"To cancel VACATION press MODE button"

NOTE: If the HOME/AWAY button is pressed during an active VACATION period, the scrolling display will read: "To cancel VACATION press MODE button."

The thermostat must be running in Program On for VACATION to have any effect. After you alter any settings, they will take effect until midnight on that day. The thermostat does not need to be running in Program On for the HOME/AWAY button to have effect.

## Emergency Heat

The Emergency Heat function is only available if your thermostat is set to control a Heat Pump.



To initiate the Emergency Heat feature, Press the EMERGENCY button. During Emergency Heat operation the thermostat will turn on the fan and auxiliary stages of heat when there is a demand for heat. The compressor used for heating and all stages of cooling will be unavailable. To exit Emergency Heat, press the EMERGENCY button.

# User Setup - Wireless Modules

## Wireless Module

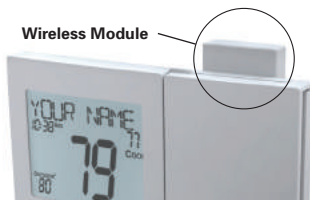
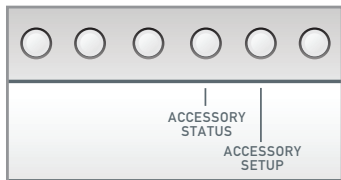

The **Accessory Status** button allows the user to view the status of wired and wireless accessories. For many of the wireless devices this status includes: Battery Level, Signal Strength & LastTime Updated.

If there is an optional wireless module installed, the **Accessory Setup** button allows the user to link or connect wireless devices to the thermostat, or the thermostat to the network.



# User Setup - Wireless Modules

## Wi-Fi Module

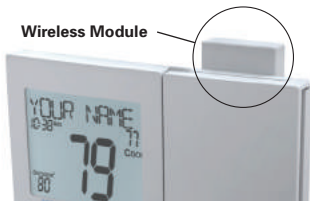
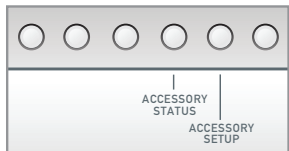

Please follow the instructions included with the Wi-Fi module to connect to an Access Point or view status. The general instructions are below.

## Wi-Fi Module

If the  is present on the display then the thermostat is connected to the Wi-Fi Access Point. If just the "dot" of this icon appears, then just the Wi-Fi module is recognized.

Press the **Accessory Status** button, then press either the Cooler button to view connected Wi-Fi sensors, OR press the Warmer button to view the Wi-Fi status and settings.

Press the Mode button to step through the connected sensors or the Wi-Fi status screens listed below.

- Wi-Fi status (connecting, connected, etc.)
- Signal strength
- Access point name
- IP address
- MAC address
- Skyport status (connecting, connected, etc.)
- Local API status (Enabled, Disabled)
- Module version

• At any time press the **Accessory Status** button to leave the status screens.

Press the Accessory Setup button to enter Wi-Fi or Skyport setup:

Press the Cooler button to configure Wi-Fi settings.

Press the Warmer button to join this thermostat to a Skyport account. If the thermostat is connected to Wi-Fi and the Internet, a Device ID will appear on the scrolling display of the thermostat. You will enter this code to add this thermostat to your Skyport account via a browser or the Skyport mobile app.

**Note:** To connect to Skyport Cloud Services, Setup Step #49 must be set to on.

# User Setup - Service Filter

These setup steps allow the user to monitor equipment runtimes and program service alerts. Service alerts are displayed in the scrolling marquee.



Press and hold FAN to clear service alert messages from the scrolling marquee.

Runtime hours or days appear in the clock display.



## Service Filter Runtime (Setup Steps 9-10, 12-13)

**Current Service Filter Runtime Hours (Setup Step 9)** - This counter keeps track of the number of hours of fan runtime in the Heating mode, Cooling mode, and in stand alone Fan operation. Press FAN to reset.

**Current Service Filter Calendar Days (Setup Step 10)** - This counter displays the total number of calendar days that have elapsed since the counter was reset to help the user track Fan runtime. Press FAN to reset.

**Set Service Filter Runtime Hours (Setup Step 12)** - This timer allows the user to specify the number of hours the fan will run before the "Replace Filter" alert will be displayed. Press COOLER continuously until OFF is displayed to disable this alert.

**Set Service Filter Calendar Days (Setup Step 13)** - This timer allows the user to specify the number of calendar days that will elapse before the "Replace Filter" alert will be displayed. Press COOLER continuously until OFF is displayed to disable this feature.

Press the **SETUP** button, then press **MODE** repeatedly until the desired setup step appears. Use the **WARMER** or **COOLER** buttons to make selection. Press **MODE** to advance to the next step. Press **SETUP** to leave the setup screens.

SETUP



MODE



## User Setup - Runtimes

*To view, set, or reset System Runtimes, press the **SETUP** button, then press **MODE**. Press **MODE** to advance to the desired setup step. Use the **WARMER** or **COOLER** buttons to adjust the value of your selection. Press **SETUP** again to leave the setup screens.*

### **UV Lamp Runtime** (setup steps 11, 14)

**Current UV Lamp Calendar Days (Setup Step 11)** - This counter displays the total number of calendar days that have elapsed to help the user track UV lamp runtime. Press **FAN** to reset.

**Set UV Lamp Calendar Days (Setup Step 14)** - This timer allows the user to specify the number of calendar days the UV Lamp will operate before the "Replace UV Lamp" alert will be displayed. Press **COOLER** continuously until **OFF** appears to disable this alert.

# User Setup - Time Period Programming

## Programming a Daily Schedule\*

*\*not available when wi-fi module is present*

**To enter Time Period Programming screens, Press and hold PROGRAM until the scrolling prompt appears.**

**OFF** -Time Period Program is off.

**RUN** -Time Period Program is running.

**HOLD TO SET** - Press and hold PROGRAM to make Time Period Programming changes.

**Select Day of Week to program** - Press the **WARMER** or **COOLER** buttons to choose the day of the week to be Press **MODE** to advance to the next step.

### Program Button

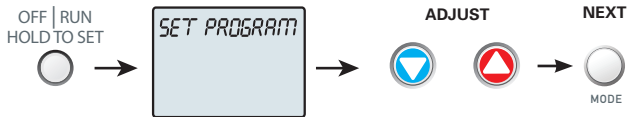

**This thermostat features four programmable time periods per 24 hour day: Morning, Day, Evening, and Night. The start time for each time period is adjustable. The stop time for each time period is the start time for the next period. Each time period, or day part may be individually disabled.**

**Select the Day to Program** - Press the **WARMER** or **COOLER** to select the desired Day or Week Part in the case of 5-2 (weekday – weekend) programming.

**Enable/Disable Morning Period** - Press the **WARMER** or **COOLER** to select ON or OFF. If the default ON is selected, then the Morning period will run complete with the Mode and Set Points selected. If OFF is selected then the Morning day part will be skipped and the thermostat will use the next day part that is enabled.

**Select Morning Mode** - Press the **WARMER** or **COOLER** to select the desired mode, which includes OFF. You may be limited by the available modes in advanced Installer setup step#2. Press **MODE** to advance to the next step.

**Select Morning Start Time** - Press the **WARMER** or **COOLER** buttons to adjust the time of day desired. Press **MODE** to advance to the next step.

## User Setup - Time Period Programming

**Select Morning Cool Setpoint** - Press the WARMER or COOLER buttons to adjust the cool setpoint desired. This step will appear if Cool or Auto Mode was selected in the step where the Morning mode is specified. Press MODE to advance to the next step.

**Select Morning Heat Setpoint** - Press the WARMER or COOLER buttons to adjust the heat setpoint desired. This step will appear if Heat or Auto Mode was selected in the step where the Morning mode is specified. Press MODE to advance to the next step.

**Repeat Enable, Mode, Start Time and Setpoint programming for Day, Evening, and Night.**

**“Copy Current Day to Next Day”** is available - Press the Mode button to Copy the current day's program to the next day. Press Mode again to continue copying the following day.

*Press the PROGRAM Button to exit Time Period Programming at any time.*

# Installer Setup

## How to Change Settings in the Setup Screens

*To enter Advanced Setup, press the **SETUP** button, then press **MODE**. Use the **WARMER** or **COOLER** buttons to adjust the value of your selection. Press **MODE** to advance to the next setup step. Press **SETUP** again to leave the setup screens.*



## Selecting Your Time Period Schedule (setup step 1)

This thermostat may be configured to be programmable or non programmable.

**7 Day Program** - Allows all seven days to be programmed independently.

**Non Program** - No advanced time period programming available.

**1 Day Program** - Allows one 24 hour day to be programmed. This same schedule will be repeated everyday the program is set to run.

**5/2 Day Program** - Allows weekdays, and weekends to be programmed independently.

## Selecting Your Available Modes (setup step 2)

**Auto-Changeover** - Allows the thermostat to turn on heating or cooling based on room temperature demand. Also allows the manual selection of HEAT only or COOL only and OFF.

**Heat and Cool** - Allows the thermostat to turn on heating or cooling depending on which one has been manually selected. Auto-Changeover is not available when this is selected.

**Heat Only** - Allows the thermostat to only turn on HEAT or OFF modes.

**Cool Only** - Allows the thermostat to only turn on COOL or OFF modes.

# Installer Setup

## **Setpoint Limits** (setup step 17)

When this feature is set to USE, the heat and cool setpoints can be restricted to preset levels, set in steps 18 and 19.

**Maximum Heat Setpoint (Setup Step 18)** - (35° - 99°).

**Minimum Cool Setpoint (Setup Step 19)** - (35° - 99°).

## **Cycles Per Hour** (setup step 20)

The Cycles Per Hour setting may limit the number of times per hour your HVAC unit may energize. For example, at a setting of 6 cycles per hour the HVAC unit will only be allowed to energize once every 10 minutes. The Cycles Per Hour limit may be overridden and reset by pressing the WARMER or COOLER buttons on the thermostat. Settings are No Limit, 2, 3, 4, 5, or 6.

## **Compressor Minimum Off Minutes** (setup step 21)

This feature allows the user to set a minimum off time for the compressor. Settings are 5 mins., 3 mins., or 0 mins.

## **Minimum Heat/Cool Setpoint Difference** (setup step 22)

This feature allows the user to set the minimum gap between Heat and Cool setpoints in **AUTO** mode. Select from 0 to 6. If setup step 2 is not set for **AUTO-CHANGEOVER**, this step will not appear.

## **Number of Heat Stages** (setup step 23)

This setting assures proper stage callouts on the thermostat display for non-heat pump applications.

## **Number of Cool Stages** (setup step 24)

This setting assures proper stage callouts on the thermostat display for non-heat pump applications.

## **Number of Aux Stages** (setup step 26)

*This feature is for heat pump application only.*

This feature allows for proper Aux Heat Staging. (0-2 stages)

## **Number of Compressor Stages** (setup step 25)

*This feature is for heat pump application only.*

This feature allows the thermostat to control 1 or 2 compressor stages when configured for heat pump.

# Installer Setup

## Deadband Settings (setup steps 27 - 36)

**The Deadband is the number of degrees or minutes that the thermostat waits before it initiates the stages of heating or cooling.**

**1st Stage Deadband (Setup Step 27)** - Specifies the minimum temperature difference between the room temperature and the desired setpoint before the first stage of heating or cooling is allowed to turn on. (1 - 6 degrees) For example, if the heat setpoint is 68° and the 1st Stage deadband is set to 2 degrees, the room temperature will need to reach 66° before the heat turns on.

**2nd Stage Deadband (Setup Step 28)** - Specifies the additional minimum temperature difference after the first stage turns on before the second stage is activated. (0° - 10°)

**3rd Stage Deadband (Setup Step 29)** - Specifies the additional minimum temperature difference after the second stage turns on before the third stage is activated. (0° - 10°)

**4th Stage Deadband (Setup Step 30) - (*Two Stage heat pump only*)** - Specifies the additional minimum temperature difference after the third stage turns on before the final stage of strip heat is activated. (0° - 10°)

**Minutes Between 1st and 2nd Stage (Setup Step 31)** - Specifies the *minimum* time (in minutes) after the first stage turns on before the second stage can turn on. (0° - 60°)

**Minutes Between 2nd and 3rd Stage (Setup Step 32)** - Specifies the *minimum* time (in minutes) after the second stage turns on before the third stage can turn on. (0° - 60°)

**Delay Between 3rd and 4th Stage (Setup Step 33)** - Specifies the *minimum* time (in minutes) after the third stage turns on before the final stage can turn on. (0° - 60°)

**Second Stage on Until Deadband (Setup Step 34)** - Specifies whether second stage will turn off at first stage deadband or remain on until the room temperature demand is satisfied. Choose between Deadband or Setpoint.

**Third Stage on Until Deadband (Setup Step 35)** - Specifies whether third stage will turn off at second stage deadband or remain on until the room temperature demand is satisfied. Choose between Deadband or Setpoint.

**Fourth Stage on Until Deadband (Setup Step 36)** - Specifies whether fourth stage will turn off at third stage deadband or remain on until the room temperature demand is satisfied. Choose between Deadband or Setpoint.



# Installer Setup

## Programming the Fan (setup steps 37 - 40)

(This feature not available on all models)

**Fan Program (Setup Step 37)** - This feature allows the fan to be programmed to turn on automatically for a specified amount of time during the day. If this feature is set to ON, the next three steps will appear.

**Minutes of Fan Runtime Per Hour (Setup Step 38)** - This setting specifies the number of minutes (0 - 60, in increments of 5) that the fan will run at the top of each hour.

**Fan Program Start Time (Setup Step 39)** - This setting specifies the hour of each day when the programmable fan feature will start.

**Fan Program Stop Time (Setup Step 40)** - This setting specifies the hour of each day when the programmable fan feature will stop. **NOTE: Setting the Stop Hour equal to the Start Hour will cause the fan to run 24 hours a day.**

## Wired Sensor Type (setup step 41)

Specifies the use of the connected, wired sensor. The choices are: Remote, Supply, Outdoor. Only the remote option allows control of the sensor.

## Fan Off Delay in Seconds (setup step 44)

This feature allows the user to increase the cooling or electric strip heating efficiency of the system. The thermostat may be programmed to continue running the fan after a call for cooling or electric strip heating has been satisfied. This delay can be set for 0, 30, 60, 90, or 120 seconds. If set to 0, the fan will not run after a call for cooling or electric strip heating has been satisfied.

## Comfort Recovery (setup step 46)

With Comfort Recovery on, the thermostat will attempt to reach the Occupied setpoint temperature at the exact time programmed into the thermostat. Comfort Recovery, only works when the thermostat enters the Occupied mode from the Unoccupied mode. For example, if the Unoccupied program is set for 11pm at 65°F heating and 85°F cooling, and the Occupied program is set for 6am at 72°F heating and 75°F cooling, the thermostat will turn the system on before 6am in an effort to bring the temperature to its correct setting at exactly 6am. The thermostat learns from experience, so please allow 4-8 days after a program change or after initial installation to give Comfort Recovery time to adjust. If used with a heat pump, electric strip heat will be disabled while Comfort Recovery is active.

# Installer Setup

## Control To Temp Source (setup step 42)

This feature allows the user to specify which temperature sensor source(s) to be used to measure room temperature for control

**Thermostat:** Uses the internal thermostat sensor only.

**Wired Remote:** Uses external temperature sensor wired to the REMOTE SENSOR contacts.

**Wireless Remote:** Uses one wireless remote temperature sensor. Choose which linked sensor to use in the subsequent step.

**Average of Wireless Remotes:** Averages the temperatures of all linked wireless remote sensors.

**Average Thermostat and Wired Remote:** Averages the temperatures of the wired remote sensor and the thermostat.

**Average All Sensors:** Averages the temperatures of the wired remote, any linked wireless remotes and the thermostat.

## Wireless Remote to Use (setup step 43)

Specifies the use of the connected, wired sensor. The choices are: Remote or Supply. The remote option allows control to the sensor, the supply does not.

## Fahrenheit or Celsius (setup step 45)

This feature allows the thermostat to display temperature in Fahrenheit or Celsius.

## Press Fan To Clear All Messages (setup step 59)

This feature allows the user to clear all current error messages from the display.

# Installer Setup

## Dry Contact Operation

### Dry Contact Polarity (Setup Step 47)

**Open (Normally Open)** - The dry contact is open until the connected device closes the circuit.

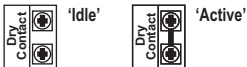

**Closed (Normally Closed)** - The dry contact is closed until the connected device opens the circuit.

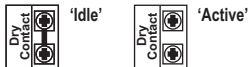

### Dry Contact Use (setup step 48)

**CONDENSATE** - If selected when the dry contact is active, the thermostat will lockout the compressor terminal(s) and "CONDENSATE PAN OVERFLOW" will appear on the display.

**VACATION** - If VACATION is selected when the dry contact is active, the thermostat will be forced into AWAY/unoccupied settings.

**FDD** - If FDD is selected when the dry contact is active, the scrolling display will read "Equipment fault". This error message will disappear when the Dry Contact is idle.

### Skyport (setup step 49)

Set to ON to allow access to Skyport services or to OFF to not allow access to Skyport services.

### Local API (setup step 50)

Set to ON to allow 3rd party software to interface with your thermostat such as home automation software.

# Installer Setup

## Resetting the Thermostat to the Factory Default Settings

(for default values see page 42 & 43, Advanced SetupTable)

If, for any reason, you desire to return all the stored settings back to the factory default settings, follow the instructions below.

**WARNING: This will reset all Time Period and Advanced Programming to the default settings. Any information entered prior to this reset may be permanently lost.**

- 1 Press and hold SETUP for 10 seconds. All icons will appear on the display.

Keep pressing the **SETUP** button until you see this screen.

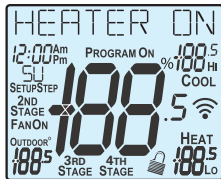

- 2 After all the icons appear, release SETUP. Press and hold FAN for 5 seconds. DEFAULTS will appear on the display.

Keep pressing the **FAN** button until you see this screen.

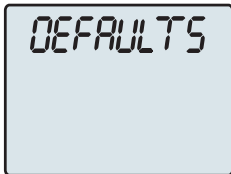

- 3 After DEFAULTS appears, release FAN. Press MODE to return to normal operation.



## Overview

Daikin thermostats support the handling of specific signals from the utility provider. The utility generated signals carry pricing information and/or setback actions that alter the comfort settings of the thermostat in order to reduce energy usage on demand. This is known as Automated Demand Response or ADR for short. You must register to participate in a utility sponsored program, if offered by your local utility, to take advantage of this feature.

## Skyport Cloud Services

From the web application the user will select Thermostat Settings from the left column. Then the Demand Response button is selected.

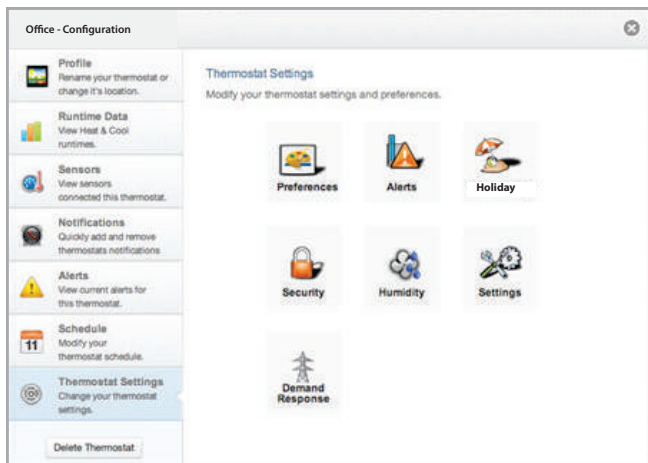

# Installer Setup - Automated Demand Response

The Demand Response configuration page, shown below, is where the thermostat is configured to respond to the energy provider's signals. It also sets operational parameters for the thermostat.

The left column of the ADR configuration page allows or prevents access by the utility. Here communication with the utility and your thermostat may be turned On or Off.

The selected utility will provide a Program ID.

The Account ID would normally be the occupants utility account number.

The screenshot shows a web-based configuration interface for a thermostat. The main window is titled "Automated Demand Response" and has two tabs: "Configuration" (selected) and "Overview".

**Left Sidebar (Office - Configuration):**

- Profile:** Rename your thermostat or change it's location.
- Runtime Data:** View Heat & Cool runtimes.
- Sensors:** View sensors connected this thermostat.
- Notifications:** Quickly add and remove thermostats notifications.
- Alerts:** View current alerts for this thermostat.
- Schedule:** Modify your thermostat schedule.
- Thermostat Settings:** Change your thermostat settings.

**Main Content Area:**

- Demand Response:** A toggle switch is currently set to **ON**.
- What is Demand Response?** A link to learn more.
- Select Utility:** A dropdown menu showing "LADWP".
- Program Id:** A text input field containing "test-program".
- Account Id:** A text input field containing "1234".
- Min & Max Settings:**
  - Event Max Cool Setpoint: 65°F
  - Event Min Heat Setpoint: 65°F
- Static Settings:**
  - Static Cool Setpoint: 78°F
  - Static Heat Setpoint: 65°F
- Offset Settings:**
  - Cool Setpoint Offset: +2
  - Heat Setpoint Offset: -2
- Price Settings:**
  - Price Trigger: 45
  - Price Dependent Action: Observe Setpoint Offsets

At the bottom of the configuration window are "Cancel" and "Save" buttons.

# Installer Setup - Automated Demand Response

The right column of the ADR configuration page is where the occupant adjusts the operational parameters for ADR. The utility may send up to 3 types of ADR signals to Skyport. These are: **1) Pricing** for the cost of energy, **2) An Offset** to the occupants' comfort setpoints, and **3) a signal** to enforce discrete or Static setpoints.

The Maximum Cooling Setpoint and Minimum Heating Setpoints for ADR events are adjusted here.

The Static Settings are applied when the utility sends a signal to allow the occupant to enforce their own discrete temperature settings during an ADR event.

The Offset Settings allow the utility to modify the Cool or Heat setpoints by the value set here during an ADR event.

A Price Trigger setting allows the occupant to set the maximum cost of energy threshold. When this threshold is exceeded the Price dependent action is enforced. This Price Trigger and Dependent action is enforced independent of an ADR event, as long as the utility sends 'real-time' pricing.

The screenshot displays the 'Office - Configuration' interface. On the left is a sidebar with navigation options: Profile, Runtime Data, Sensors, Notifications, Alerts, Schedule, and Thermostat Settings. The main content area is titled 'Automated Demand Response' and is split into 'Configuration' and 'Overview' tabs. The 'Configuration' tab is active, showing a 'Demand Response' toggle set to 'ON'. Below this are fields for 'Select Utility' (LADWP), 'Program Id' (test-program), and 'Account Id' (1234). To the right, there are several sections: 'Min & Max Settings' with 'Event Max Cool Setpoint' and 'Event Min Heat Setpoint' both at 65°F; 'Static Settings' with 'Static Cool Setpoint' at 78°F and 'Static Heat Setpoint' at 65°F; 'Offset Settings' with 'Cool Setpoint Offset' at +2 and 'Heat Setpoint Offset' at -2; and 'Price Settings' with 'Price Trigger' at 45 and 'Price Dependent Action' set to 'Observe Setpoint Offsets'. A 'Save' button is at the bottom right.

# Installer Setup - Automated Demand Response

Selecting the Overview tab of the ADR page will cause a summary of ADR events to be displayed.

The screenshot displays the 'Office - Configuration' window with a sidebar on the left and a main content area on the right. The sidebar contains several menu items: Profile, Runtime Data, Sensors, Notifications, Alerts, Schedule, and Thermostat Settings, each with a brief description. At the bottom of the sidebar is a 'Delete Thermostat' button. The main content area is titled 'Automated Demand Response' and has two tabs: 'Configuration' and 'Overview'. The 'Overview' tab is active and shows a table of ADR events. Below the table are 'Cancel' and 'Save' buttons. At the bottom of the main area, there are icons for 'Security', 'Humidity', 'Settings', and 'Demand Response'.

Event Id	Event Type	Status	Start Time	Stop Time
1233407844	Price	Success	08/10/2014 1:00pm	08/10/2014 2:00pm
1233407844	Price	Success	08/15/2014 4:00pm	08/15/2014 5:00pm



## Installer Setup - Automated Demand Response

### **ADR** (setup step 51)

Controls whether you want the thermostat to possibly respond to signals from the utility provider. Select ON to allow this and to have steps 52-58 appear.

### **Price Dependent Action** (setup step 52)

Allows the user to determine what action is taken when the price rises above the set threshold. Note that the threshold price is only adjustable via Skyport.

**None** – take no action when the set price threshold is exceeded

**Observe Setpoint Offsets** – will offset the heat and cool setpoints by the amounts specified in setup steps 57 and 58

**Observe Static Setpoints** – will set the heat and cool setpoints to the values specified in setup steps 55 and 56

### **Event Max Cool Setpoint** (setup step 53)

### **Event Min Heat Setpoint** (setup step 54)

Specifies the range of allowable setpoint adjustments to be enforced when any ADR signal has been received from the utility. Since you might be paying more for energy while an event is active, you can impose tighter limits on setpoint ranges that are only enforced during the event.

### **Static Cool Setpoint** (setup step 55)

### **Static Heat Setpoint** (setup step 56)

Specifies the setpoints that will come into use during an event when the PRICE DEPENDENT ACTION is set to OBSERVE STATIC SETPOINTS

**Cool Setpoint Offset** (setup step 57)

**Heat Setpoint Offset** (setup step 58)

Specifies how much the current setpoints in effect prior to an event will be altered during an event when the PRICE DEPENDENT ACTION is set to OBSERVE SETPOINT OFFSETS. The heat setpoint can be automatically lowered by 1 to 10 degrees while the cool setpoint can be automatically raised by 1 to 10 degrees

### **DISPLAY INDICATIONS WHEN AN ADR EVENT IS HAPPENING**

After setting your desired values for use during an ADR event, the scrolling display will give a little information when an event is pending or active. For instance, when an ADR event has been sent to your thermostat, you might see ADR STARTS at 4:15 to notify you of a pending event. Once active, you might see ADR STOPS at 5:30. If you have configured a threshold for cost of energy past which you want to trigger an event, you will see PRICING EVENT on the display. When an event is active, you can press any of COOLER, WARMER or MODE buttons, followed by the WARMER to opt out of the event.

# Installer Setup

## Locking/Unlocking the Keypad

To prevent unauthorized use of the thermostat, the front panel buttons may be disabled. To disable, or 'lock' the keypad, press and hold the MODE button. While holding the MODE button, press the WARMER and COOLER buttons together. The  icon will appear on the display, then release the buttons.

Press all three buttons in the order outlined above for keypad lockout

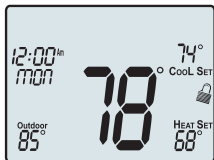

MODE

To **unlock** the keypad, press and hold the MODE button. While holding the MODE button, press the WARMER and COOLER buttons together. The  icon will disappear from the display, then release the buttons.

# Technician Setup

To enter *Technician Setup*, press and hold the **SETUP** button for 10 seconds. After all the icons appear, press **MODE**. The version number of the thermostat will appear in the scrolling text. Press **MODE** to advance to the next step. Use the **WARMER** or **COOLER** buttons to adjust the value of your selection. To leave *Technician Setup*, press **SETUP**.

Hold for 5 seconds

All icons appear

Press **MODE** to advance through the setup steps

SETUP

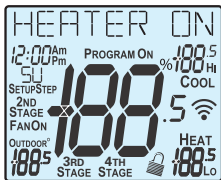

MODE

Press **WARMER** or **COOLER** to adjust the selection



MODE

**Technician Setup** is for diagnostic and testing purposes and is intended for use by a qualified technician. See page 15 for more detailed instructions.

**Technician Setup** contains the following options:

- View the version number of the thermostat.
- View the jumper setting of **J1** (Gas/Electric or Heat Pump), **J2** (Reversing Valve: RV=O or RV=B), and **J3** (Fan: Gas or Electric) jumpers located on the back of the thermostat. (Remove thermostat from backplate for access)
- View the state of the Dry Contact and Fault terminals.
- Turn on equipment outputs for testing.
- Calibrate thermostat and remote sensors.

# Advanced Setup Table

Df = Factory Default Setting

Step#	Description	Pg#	Range	Df
1	Prog Mode	25	Non, 1 Day, 5/2 Day, 7 Day	7
2	Available Modes	25	Heat/Cool/Auto/Off, Heat/Cool/Off, Heat/Off, Cool/Off	Heat/Cool/Auto/Off
3	Backlight	16	On, Off	Off
4	Backlight Level	16	Off thru 7 levels of brightness	Level 5
5	Night Dimmer	16	On/Off	Off
6	Night Dimmer Brightness	16	Off thru 7 levels of brightness	2 (20%)
7	Night Dimmer StartTime	16	12A-12A	8:00P
8	Night Dimmer StopTime	16	12A-12A	6:00A
9	Current Service Filter Runtime Hours	21	0-1999 Hours	0
10	Current Service Filter Calendar Days	21	0-720 Days	0
11	Current UV Lamp Calendar Days	22	0-720 Days	0
12	Set Service Filter Runtime Hours	21	0-1950 hours	0
13	Set Service Filter Calendar Days	21	0-720 Days	0
14	Set UV Lamp Calendar Days	22	0-720 Days	0
15	Language	16	English, Espanol, Francois	English
16	Scrolling Method	17	"L-R Slow, L-R Fast, Word L-R Slow, Word L-R Fast, Whole Word L Slow, Whole Word R Slow, Whole Word Ctr. Fast, Whole Word Ctr. Slow"	"Whole Words Center Fast"
17	Setpoint Limits	26	No, Use	No
18	Max Heat Setpoint	29	35 - 99 Degrees	74
19	Min Cool Setpoint	29	35 - 99 Degrees	70
20	Cycles Per Hour	26	No Limit, 2, 3, 4, 5, 6	6
21	Compressor Minimum Off Minutes	26	0, 3, 5 Minutes	5
22	Min. Heat/Cool Setpoint Difference	26	0 - 6 Degrees	2
23	Number of Heat Stages	26	0 - 3	2
24	Number of Cool Stages	26	0 - 2	1
25	Number Of Compressor Stages	26	1, 2	1
26	Number of Aux Stages	29	0, 1, 2	0
27	1st Stage Deadband	27	1 - 6 Degrees	2
28	2nd Stage Deadband	27	0 - 10 Degrees	2
29	3rd Stage Deadband	27	0 - 10 Degrees	2
30	4th Stage Deadband	27	0 - 10 Degrees	2
31	Minutes Between 1st and 2nd Stage	27	0 - 60 Minutes	2
32	Minutes Between 2nd and 3rd Stage	27	0 - 60 Minutes	2
33	Minutes Between 3rd and 4th Stage	27	0 - 60 Minutes	2
34	2nd StageTurnoff Point	27	Deadband, Setpoint	Deadband

cont. next page

# Advanced Setup Table

Df = Factory Default Setting

Step#	Description	Pg#	Range	Df
35	3rd Stage Turnoff Point	27	Deadband, Setpoint	Deadband
36	4th Stage Turnoff Point	27	Deadband, Setpoint	Deadband
37	Fan Program	28	On, Off	Off
38	Minutes of Fan Runtime	28	0-60	0
39	Fan Program Start Time	28	12:00A - 12:00A	7:00A
40	Fan Program Stop Time	28	12:00A - 12:00A	7:00A
41	Wired Sensor Type	28	Remote, Supply, Outdoor	Remote
42	Control to Temp Source	29	Thermostat, Wired Remote*, Wireless Remote, Average of Wireless Remotes, Average Thermostat and Wired Remote*, Average All Sensors. *Option only if prior step = "Remote"	Thermostat
43	Wireless Remote to Use	29	list of wifi sensors currently linked to thermostat. * This step only appears if prior step = "Wireless Remote"	first linked sensor in  list
44	Fan Off Delay	28	0 - 120 Seconds	0
45	F/C	29	Fahrenheit (F), Celsius (C)	F
46	Comfort Recovery	28	On, Off	Off
47	Dry Contact Polarity	30	Open, Closed	Open
48	Dry Contact Use	30	Condensate, Vacation, FDD,	Vacation
49	Skyport	30	On, Off	On
50	Local API	30	On, Off	Off
51	ADR	36	On, Off	Off
52	Price Dependent Action	36	None, Observe Setpoint Offset, Observe Static Setpoints	None
53	Event Max Cool Setpoint	36	65 - 85	85
54	Event Min Heat Setpoint	36	65 - 85	65
55	Static Cool Setpoint	36	65 - 85	78
56	Static Heat Setpoint	36	65 - 85	68
57	Cool Setpoint Offset	37	1 to 10	2
58	Heat Setpoint Offset	37	-1 to -10	-2
59	Press Fan To Clear All Messages	29		

# Troubleshooting

- **SYMPTOM:** The air conditioning does not attempt to turn on.  
**CAUSE:** The compressor timer lockout may prevent the air conditioner from turning on for a period of time.  
**REMEDY:** Consult the Owner's Manual in the Installer Setup section to defeat the Cycles Per Hour (*page 27*).
- **SYMPTOM:** The display is blank.  
**CAUSE:** Lack of proper power.  
**REMEDY:** Make sure the power is on to the furnace and that you have 24vac between **R & C**.
- **SYMPTOM:** The air conditioning does not attempt to turn on.  
**CAUSE:** The cooling setpoint is set too high.  
**REMEDY:** Lower the cooling setpoint or lower the cooling set-point limit. *See Setpoint Limits (page 26)*.
- **SYMPTOM:** The heating does not attempt to turn on.  
**CAUSE:** The heating setpoint is set too low.  
**REMEDY:** Raise the heating setpoint or raise the heating set-point limit. *See Setpoint Limits (page 26)*.
- **SYMPTOM:** When controlling a residential heat pump, and asking for cooling, the heat comes on.  
**CAUSE:** The thermostat reversing valve jumper is set for "**B**".  
**REMEDY:** Set the reversing valve jumper for "**O**".
- **SYMPTOM:** When calling for cooling, both the heat and cool come on.  
**CAUSE:** The thermostat equipment jumper is configured for "**HP**" and the HVAC unit is a Gas/Electric.  
**REMEDY:** Set the equipment jumper for "**Gas**".
- **SYMPTOM:** When the Program button is pressed, the display reads "DISABLED".  
**CAUSE:** Program mode is set to "**NON PROGRAM**".  
**REMEDY:** Set Program Mode (Setup 1) to **1**, **5/2**, or **7 Day**. *See Selecting Your Program Mode (page 25)*.

# Index

## A

### Alerts

*see Runtime*

### Accessory, 20

Setup, 20

### Auto

adjust temperature, 6  
changeover, 3  
fan, 7  
mode, iii, 3, 7

## B

**b reversing valve, 10, 44**

**Backplate, 11**

**Balance Point, 34**

### Buttons

accessory, 2  
cooler (down) 1  
emergency heat, 2, 19  
fan, 1, 2, 7  
front panel, 1, 2  
mode, 1, 6  
outdoor, 1, 8  
program, 1, 26  
set clock, 2, 6  
setup, 17  
vacation, 2, 19  
up (warmer), 1, 7

## C

**C, 34**

**Calibration, 16, 40**

**Celsius, 34**

### Clock

display, 3  
setting, 6

**Comfort Recovery, 31**

**Compressor Lockout,  
19, 33**

### Cool

To dehum, 32  
1st stage deadband,  
*see Deadband*  
minutes of runtime, 25  
2nd stage deadband,  
*see Deadband*  
min. of runtime, 23  
turn off temp., 23  
droop, *see Deadband*  
electric/heat pump, 10  
icon, 2  
indicator, 1  
mode, 2, 5  
overcool, *see Overcool*  
program, *see Program*  
runtime, *see Runtime*  
setpoint, 3, 6, 20

**Condensate Drain Pan,  
37**

**Copy Function**

*see Program*

**Cycles Per Hour, 29**

## D

### Day

icon, 3  
programming, 6, 26, 27

### Deadband

1st stage, 30  
2nd stage, 30  
3rd stage, 30

### Delay

fan-off, *see Fan*  
time between stages,  
*see Time Delay*

### Differential

heat and cool, 29

**Disabled Keypad**

*see Keypad Lockout*

**Drain Pan Overflow**

**Alarm, *see Dry Contact***

**Dry Contact**

operation, 37  
polarity, 37  
service pan, 37  
vacation, 37



# Index

## E

### Electric Heating

AuxHeat icon, 5  
jumper setting, 12  
reheat, 32

### Emergency Heat, 2, 19

## F

### Factory Defaults

settings, 41, 42, 43  
resetting, 38

### Fahrenheit, 34

### Fan

button function, *see*  
*Buttons*  
on during heat, *see*  
*Electric Heat*  
on icon, 5  
program, *see*  
*Programmable Fan*  
runtime, 24  
2nd stage heat, *see*  
*Emergency Heat*

## G

### Gas/Electric Furnace

jumper, 12

### Green Cool Indicator, 1 Heat

1st stage deadband,  
*see Deadband*  
min. of runtime, 25  
2nd stage deadband,  
*see Deadband*  
minutes of runtime, 25  
3rd stage deadband,  
*see Deadband*  
deadband, *see*  
*Deadband*  
droop, *see Deadband*  
electric/heat pump, 12  
icon, 3  
indicator red, 1  
mode, 1, 3, 6  
program, *see Program*  
runtime, *see Runtime*  
setpoint, 7

## H

### Heat Pump

AuxHeat, 5, 12, 19, 25  
AUXHeat Lockout, 33  
emergency heat, 19  
jumper setting, 12  
multi-stage, 14, 15  
icon, 5

## J

### Jumpers

ELEC, 12  
electric heat, 12  
gas electric, 12  
heat pump, 12  
reversing valve, 12  
viewing, 16

## K

### Keypad Lockout, 39

# Index

## L

**LCD, 3, 4, 5**

**Language, 17**

**Locked Indication,**  
*see Keypad Lockout*

## M

**Manual**

changeover, 6  
cool, 6, 7  
heat, 6, 7

**Mode, 3, 6, 7, 28**

**Multi-stage  
Operation, 29, 30**

## N

**Non-Programmable  
Thermostat, 28**

**Normally Open/Closed,**  
dry contact, 37

## O

**O Reversing Valve**  
*see Reversing Valve*

**Off Mode, 3, 6**

**Outdoor**  
button, *see Buttons*  
viewing temperature, 8

**Overcool, 32**

## P

**Pan, Service**  
*see Dry Contact*

**Polarity, *see Dry Contact***

**Program**  
Copy, 27  
daily schedule, 26, 27  
mode, 28  
worksheet, *back page*

**Programmable Fan, 31**

**Programmable  
Thermostat, 26**

**Programming a Daily  
Schedule, 26, 27**

## R

**Remote Sensor**  
calibrate, 33, 14  
control to, 34  
outdoor temperature,  
*see Outdoor*  
viewing, 20

**Reset**  
Alert Messages, 25  
thermostat settings,  
*see Factory Defaults*  
runtime  
fan/filter, 24  
UV light, 25

**Reversing Valve, 12**

**Runtime**  
resetting, *see Reset*  
setting,  
service filter, 24  
UV light, 25  
viewing,  
cool, 25  
heat, 25  
UV lamp, 25

# Index

## S

### Schedule

Daily, *see Program*

### 2nd stage turn off temperature, 30

### Sensor

outdoor, *see Outdoor remote*, *see Remote thermostat*, *see Thermostat*

### Service

filter icon, *see Reset pan icon*, *see Dry Contact*  
UV light, *see Reset*

### Set Clock, *see Clock*

### Setpoint

cool, *see Cool Limits*, 29

## T

### Technician Setup, 16, 40

### Thermostat Sensor

calibrate, 16, 40

### Three Stage Heat, 14, 30

### Time, *see Clock*

### Time Delay,

compressor lockout, 29  
cycles per hour, 29  
1st to 2nd stage, 30  
2nd to 3rd stage, 30  
3rd to 4th stage, 30

### Time Schedule, *see Program*

### Troubleshooting, 44

## U

### UV Light

resetting, 25  
runtime, *see Runtime setting*, *see Runtime*

## V

### Vacation

button, *see Buttons mode*, 19  
programming, 19  
setpoints, 19

## W

### W3, *see Jumpers*

### Wireless Module, 20

### Warranty, 46

### Wi-Fi, 21

## Y

### Y2, *see Jumpers*

# Warranty

**One-Year Warranty** - This Product is warranted to be free from defects in material and workmanship. If it appears within one year from the date of original installation, whether or not actual use begins on that date, that the product does not meet this warranty, a new or remanufactured part, at the manufacturer's sole option to replace any defective part, will be provided without charge for the part itself provided the defective part is returned to the distributor through a qualified servicing dealer.

**THIS WARRANTY DOES NOT INCLUDE LABOR OR OTHER COSTS** incurred for diagnosing, repairing, removing, installing, shipping, servicing or handling of either defective parts or replacement parts. Such costs may be covered by a separate warranty provided by the installer.

**THIS WARRANTY APPLIES ONLY TO PRODUCTS IN THEIR ORIGINAL INSTALLATION LOCATION AND BECOMES VOID UPON REINSTALLATION.**

**LIMITATIONS OF WARRANTIES – ALL IMPLIED WARRANTIES (INCLUDING IMPLIED WARRANTIES OF FITNESS FOR A PARTICULAR PURPOSE AND MERCHANTABILITY) ARE HEREBY LIMITED IN DURATION TO THE PERIOD FOR WHICH THE LIMITED WARRANTY IS GIVEN. SOME STATES DO NOT ALLOW LIMITATIONS ON HOW LONG AN IMPLIED WARRANTY LASTS, SO THE ABOVE MAY NOT APPLY TO YOU. THE EXPRESSED WARRANTIES MADE IN THIS WARRANTY ARE EXCLUSIVE AND MAY NOT BE ALTERED, ENLARGED, OR CHANGED BY ANY DISTRIBUTOR, DEALER, OR OTHER PERSON WHATSOEVER.**

**ALL WORK UNDER THE TERMS OF THIS WARRANTY SHALL BE PERFORMED DURING NORMAL WORKING HOURS. ALL REPLACEMENT PARTS, WHETHER NEW OR REMANUFACTURED, ASSUME AS THEIR WARRANTY PERIOD ONLY THE REMAINING TIME PERIOD OF THIS WARRANTY.**

**THE MANUFACTURER WILL NOT BE RESPONSIBLE FOR:**

1. Normal maintenance as outlined in the installation and servicing instructions or owner's manual, including filter cleaning and/or replacement and lubrication.
2. Damage or repairs required as a consequence of faulty installation, misapplication, abuse, improper servicing, unauthorized alteration or improper operation.
3. Failure to start due to voltage conditions, blown fuses, open circuit breakers or other damages due to the inadequacy or interruption of electrical service.
4. Damage as a result of floods, winds, fires, lightning, accidents, corrosive environments or other conditions beyond the control of the Manufacturer.
5. Parts not supplied or designated by the Manufacturer, or damages resulting from their use.
6. Manufacturer products installed outside the continental U.S.A., Alaska, Hawaii, and Canada.
7. Electricity or fuel costs or increases in electricity or fuel costs for any reason whatsoever including additional or unusual use of supplemental electric heat.
8. ANY SPECIAL INDIRECT OR CONSEQUENTIAL PROPERTY OR COMMERCIAL DAMAGE OF ANY NATURE WHATSOEVER. Some states do not allow the exclusion of incidental or consequential damages, so the above may not apply to you.

This warranty gives you specific legal rights and you may also have other rights which may vary from state to state.

# Programming Worksheet - see page 23

DAY	PERIOD	START TIME	COOL	HEAT	
<b>MONDAY</b>	Morning				
	Day				
	Evening				
	Night				
<b>TUESDAY</b>	Morning				<i>Copy Mon to Tues</i> <input type="checkbox"/> No <input type="checkbox"/> Yes
	Day				
	Evening				
	Night				
<b>WEDNESDAY</b>	Morning				<i>Copy Tues to Wed</i> <input type="checkbox"/> No <input type="checkbox"/> Yes
	Day				
	Evening				
	Night				
<b>THURSDAY</b>	Morning				<i>Copy Wed to Thurs</i> <input type="checkbox"/> No <input type="checkbox"/> Yes
	Day				
	Evening				
	Night				
<b>FRIDAY</b>	Morning				<i>Copy Thurs to Fri</i> <input type="checkbox"/> No <input type="checkbox"/> Yes
	Day				
	Evening				
	Night				
<b>SATURDAY</b>	Morning				<i>Copy Fri to Sat</i> <input type="checkbox"/> No <input type="checkbox"/> Yes
	Day				
	Evening				
	Night				
<b>SUNDAY</b>	Morning				<i>Copy Sat to Sun</i> <input type="checkbox"/> No <input type="checkbox"/> Yes
	Day				
	Evening				
	Night				

Patent Pending



Printed on recycled paper.  
P/N 88-1207 Rev. 1 07/17

